



TS

ASSEMBLY MANUAL



Scan this QR code with smart phone to watch 3D assembly animation video.



VersaClimber® and the VersaClimber logo are trademarks or registered trademarks of Heart Rate, Inc. dba VersaClimber in the U.S. and other countries.

Publication Date: March, 2021

Country of First Publication: United States of America

Author: Heart Rate, Inc.

No portion of this guide may be copied, reproduced or distributed other than by written permission of Heart Rate, Inc. The unauthorized reproduction or distribution of this copyrighted work is illegal.

The information in this guide is distributed on an "as is" basis without warranty. While every precaution has been taken in the preparation of this guide, Heart Rate, Inc. shall not have any liability, express or implied, to any person or entity with respect to any loss or damage caused or alleged to be caused directly or indirectly by the instructions contained in this guide.

Heart Rate Inc., 1411 E. Wilshire Ave, Santa Ana CA 92705



TABLE OF CONTENTS

TOOLS REQUIRED.....	1
PARTS LIST.....	2
SPECIFICATIONS.....	3
TS PART IDENTIFICATION.....	4

ASSEMBLY AND INSTALLATION

ASSEMBLY.....	5-8
PLASTIC BOLT CAPS.....	8
NOTICES.....	9
POWER SUPPLY TOP or BOTTOM	10-11

TOUCH SCREEN

CONNECTING TO WIFI.....	13-14
CREATING USER ACCOUNT.....	15
START A WORKOUT	16
CALORIES, HEART RATE, FEET CLIMBED.....	17
HOW TO SAVE AND EXIT	18
STATS / PAST WORKOUTS.....	18-19
HEART RATE	20
TROUBLE SHOOTING.....	21
MAINTENANCE.....	22
WARRANTY.....	23

TOOLS REQUIRED FOR ASSEMBLY OF A SINGLE TS UNIT:

-One Phillips screw driver.

-Two 9/16" wrenches.

-Two able bodied persons are required for assembly.

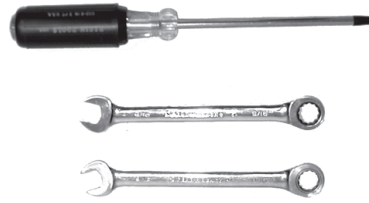

UNPACKING INSTRUCTIONS

The following items are packaged in the wood shipping crate.

EQUIPMENT: (single unit TS)

- Vertical frame/post with control console attached.
- Two foot pedals.
- Two quick release hand grips.
- One front curved tubing base and two stable pads with nuts.
- One back straight tubing base.
- One brace, post to back base.
- Two side handrails.
- One metal pump cover
- One transformer / 110 volt AC Adapter.



PARTS LIST

A. (2) Base Bolts 3/8" x 3 3/4" long



A.

B. (4) Base Bolts 3/8" x 5/8" long



B.

C. (3) 3/8" lock nuts



C.

D. (3) Side Hand Rail Bolts 3/8" x 4 1/4" long



D.

E. (1) 3" Hand Rail Spacer



E.

F. (3) 3/8" lock nuts



F.

G. (4) Foot Pedal Bolts 3/8" x 1 1/2"



G.

H. (1) 3/8" lock nut



H.

I. (16) Plastic Cap Covers



I.

TS VERSACLIMBER SPECIFICATIONS

PHYSICAL SIZE

Height	7 feet, 10 Inches (2.1 m x 25 cm)
Footprint	42 Inches x 45 Inches (106 cm x 114 cm)
Weight	155 pounds (70 kg)

FUNCTIONAL FEATURES

Pedal Step Height	0 to 20" (0 x 50 cm)
Arm Stroke Length	0 to 20" (0 x 50 cm)
Hydraulic Climb Rate Control	Hydraulic
Force Control	0 To 500 lbs. (226 kg)
Climb Angle	75 Degrees
Vertical Lift Factor (% slope)	96.6 Percent

POWER SUPPLY

Power Cord	110v
------------	------

USER ACCOMMODATIONS

Level of Physical Fitness	Novice To Elite
Climber's Height	4' 2" to 6' 7" (1.21 m x 2.1 m)
Climber's Weight	65 lbs. to 352 lbs. (30 - 160 kg)

TS PART IDENTIFICATION

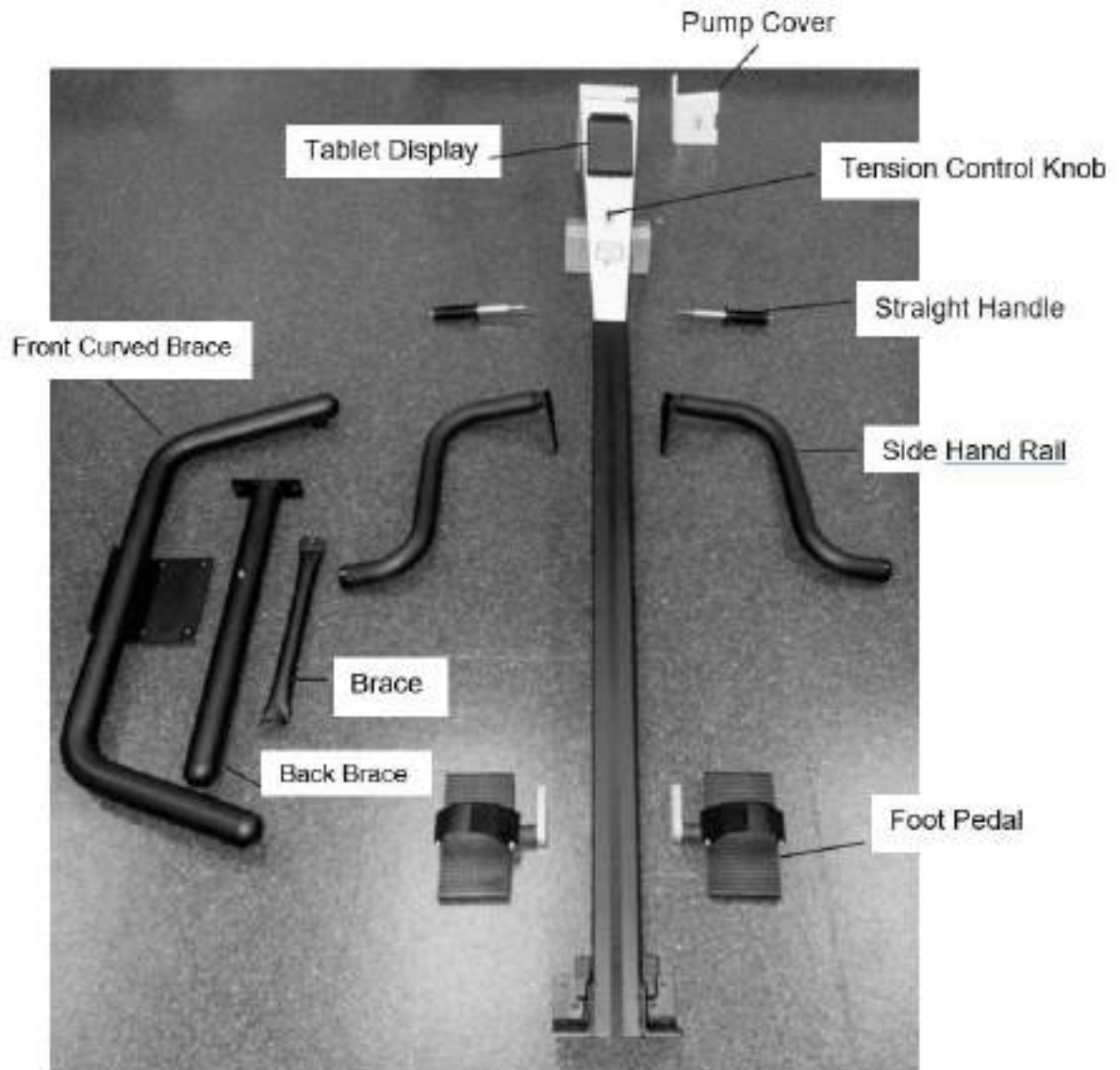

- 1.** Screw in two Stabilizer Knobs onto the corners of front curved U base.

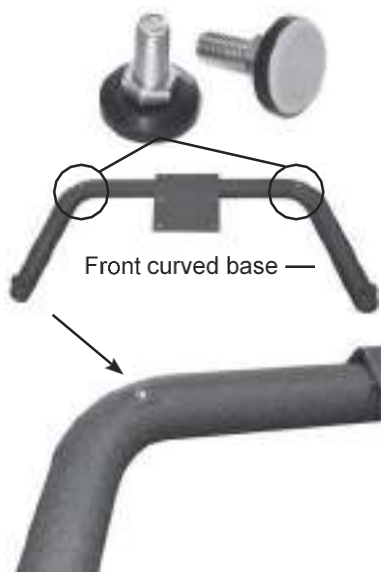

- 2.** Locate the threaded inserts on the underside of the front curved U base at the sections that curve.



- 3.** Make sure stabilizers are screwed all the way into front curved U base before assembling TS VersaClimber.



- 4.** Screw down knobs until pads are touching floor or just resting on.



- 5.** Once both knobs are set into position, spin the hex nut up until secured at the bottom of the front base tube then tighten firmly with a 9/16" wrench, to lock stabilizer in place.



6. Attach the front curved tubular floor brace to the post. Using four hex head bolts $3/8''$ x $5/8''$ long bolts, screw down until firmly tight.



7. Screw in (4) self tightening base bolts.



8. Securely TIGHTEN all (4) bolts.



9. Lift and hold main post in the vertical upright position.



10. Attach back tubular floor brace to post with (2) hex head bolts $3/8''$ x $3\frac{3}{4}''$ long and (2) lock nuts. **DO NOT TIGHTEN FULLY AT THIS TIME.**



11. Attach tubular brace between main post and back tubular floor base with (2) $3/8''$ lock nuts **DO NOT TIGHTEN FULLY AT THIS TIME.**



12. After tubular brace is in place, go back and **FULLY TIGHTEN** the (2) 3 ¾" long base bolts.



13. Then go back and **TIGHTEN FULLY** the TOP lock nut on the tubular brace.



14. Next, tighten the **BOTTOM** lock nut on the back brace to complete post assembly.



15. Attach foot pedals with "L" shape bracket pointing up, using (2) 3/8" x 1 ½" long hex head bolts.



16. Securely **TIGHTEN** foot pedals.

NOTE: It is recommended to visually inspect foot pedals and tighten bolts every (2) months and pedal shaft replacement every three years.



17. Attach side handrails with (3) hex head bolts 4" long and (3) 3/8" lock nuts.



18. Insert 3" long spacer and **FULLY TIGHTEN** all 3 bolts and nuts.



Install quick release handgrips by depressing pin with thumb and inserting into top lug at the upper portion of VersaClimber.

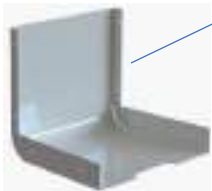

Pump Cover



19. With the post supported or after VersaClimber is upright, slip pump cover into place. Attach with four Phillips pan head screws 1/4" x 1/4" long. **DO NOT OVER TIGHTEN.**



20. Plug the transformer into the back of the post and a 110 volt wall socket.

Plastic Cap Covers



X 16 Cap covers

Included are 16 plastic Bolt / Nut cap covers. These cap covers will help reduce corrosion from extra moisture caused by sweating.

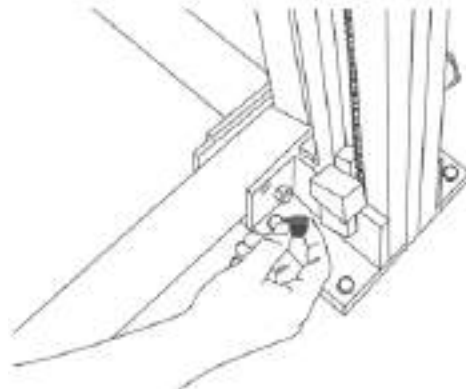

Locate bolts and nuts. Firmly press caps on.

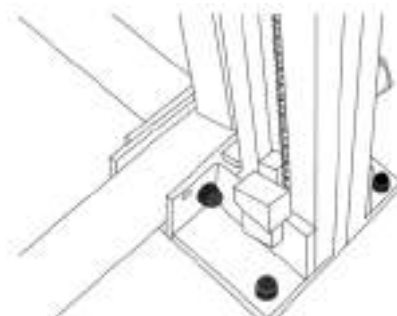

THE HYDRAULIC SYSTEM

The hydraulic system consists of a heavy duty, reversible gear pump. A flow control valve (black knob) is connected between the input and the output ports. A clear oil fill reservoir is located on top of the pump, at the very top of the VersaClimber.

NOTE:

The oil in the pump clear pump reservoir always darkens in color and most of the time, turns black in color—this is normal.

WARNING NOTICE:

In order to maintain highest safety level of equipment, a regular examination is required for damage and wear. This requires a visual inspection of connectors, cables, chains, sprockets, pedals, handles etc. on a regular basis.

NOTICE:

Replace defective components immediately and/or keep equipment out of use until repair is made.

More questions?

Please contact us: support@versaclimber.zendesk.com

1. Plug the power into the bottom of unit 110v wall outlet.

For convenience, the VersaClimber TS can be powered from the base or the top of the VersaClimber.

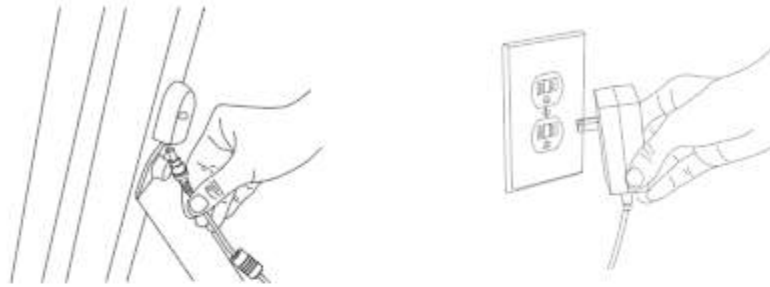

1a. Plug the power into top of unit OPTION.

For convenience, the VersaClimber TS does have the option to connect a power source to the top of unit.

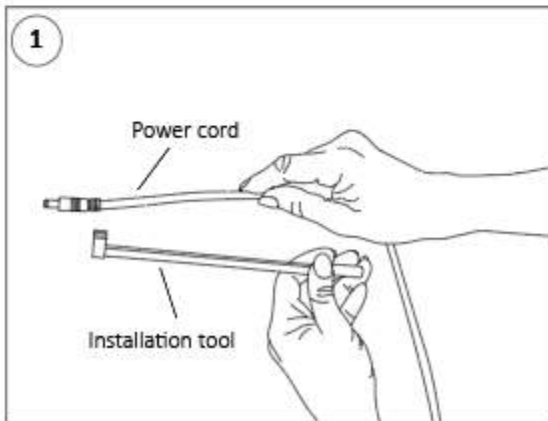
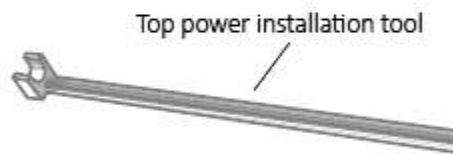

1 Align end of power cord plug with installation tool.

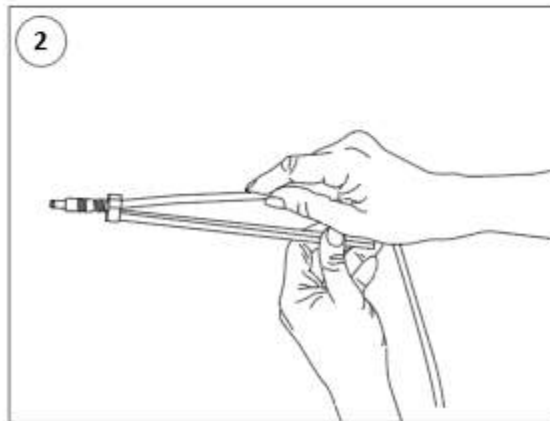

2 Adjust the end of power cord so it rests in U shaped cradle.

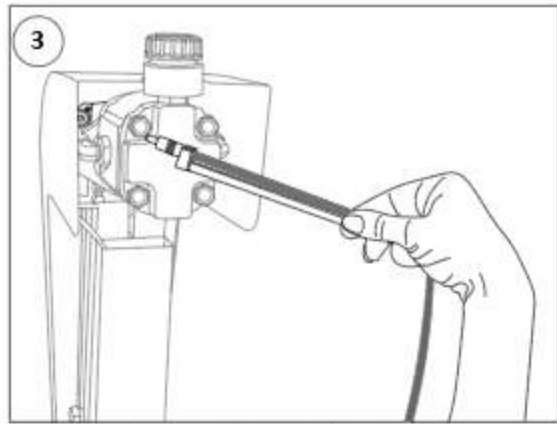
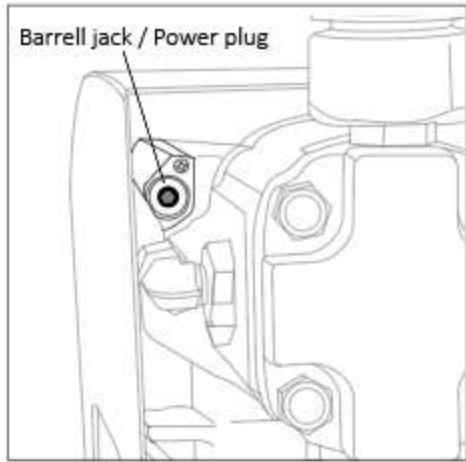

3 Using a light source, locate barrel jack which is accessed on the backside, top of unit.

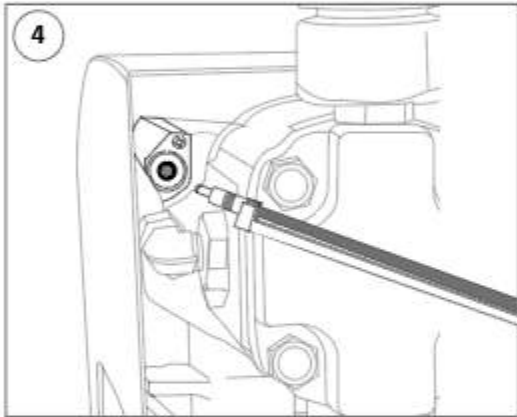

4 While holding both together, guide end of power cord into barrel jack. Push firmly to make connection.

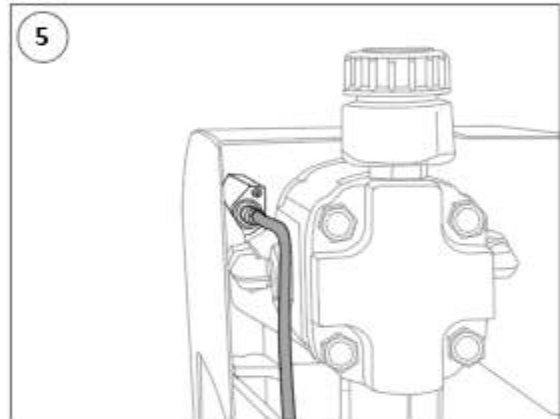

5 Using tool plug in power cord into barrel port.

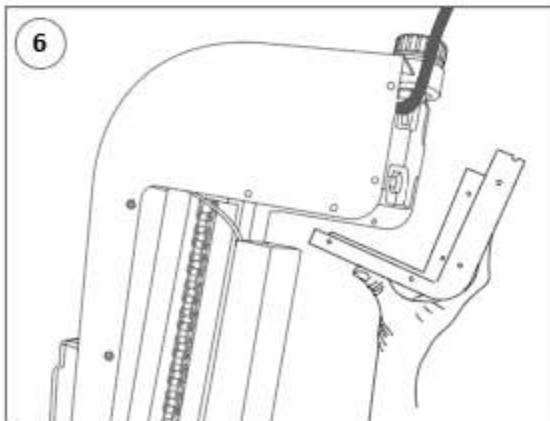

6 When power cord plugged in and secured, attach back cover while guiding wire up and through reservoir clearance hole in housing.

Tablet Specs / Features

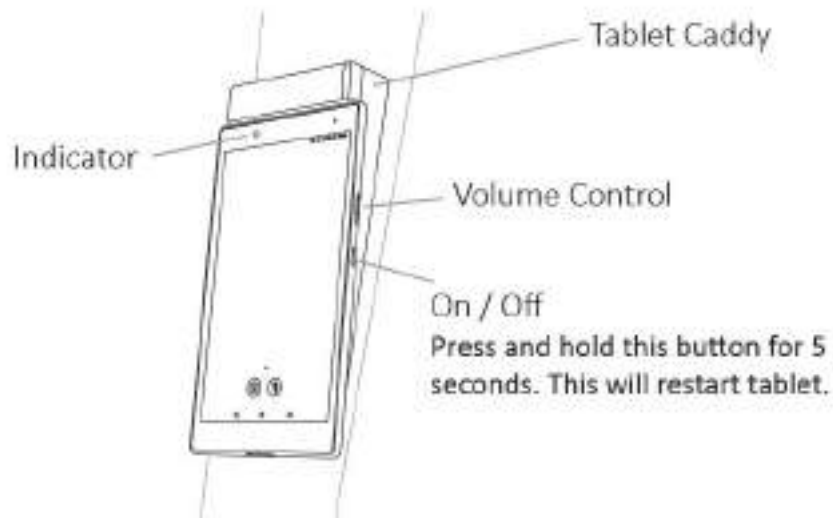

2. Power on the touch screen.

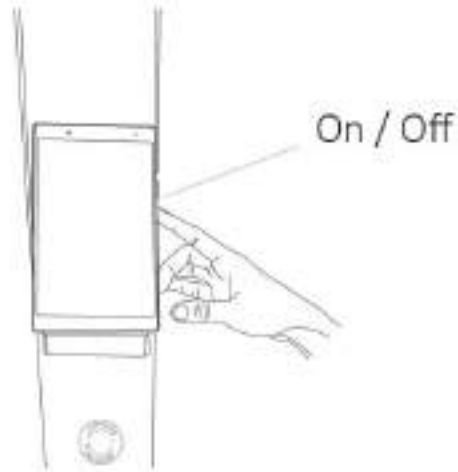

The power switch is on the right side of the touch screen. Press and hold it for 5 seconds

3. Connect to WIFI

Launch Screen



1. To access WIFI, Swipe down twice from the top.

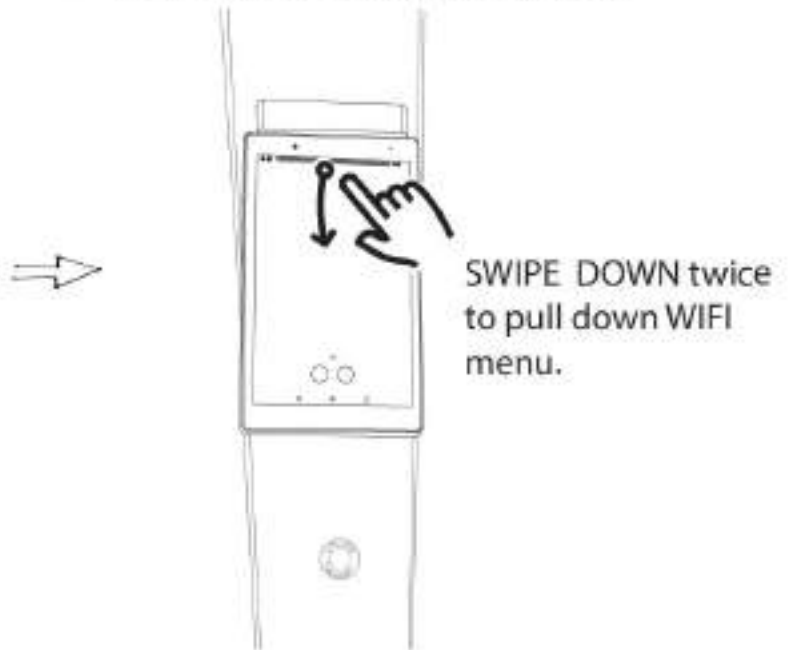

3a. Connect to WIFI

2. Press and hold WIFI symbol.



3. Locate WIFI Router. TAP to select.

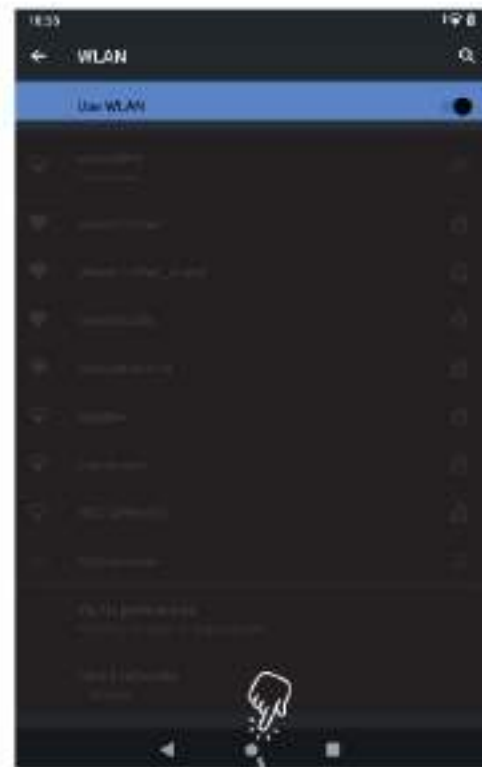
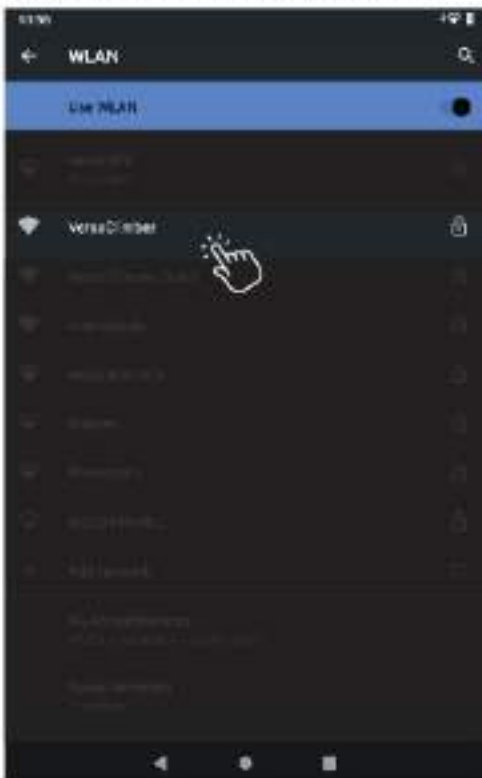

4. After selecting WIFI, TAP the circle icon (HOME button) at the bottom of screen, this will return back to TAP to launch screen.

4. Create an Account

TAP to launch



Tap ADD USER



The sign in / log in screen.

NOTE: If already registered, sign in with email & password.
Tap REGISTER to create an account.



Complete the user profile fields.
Tap SIGN UP.



5. Home Screen

The Home Screen shows total stats for the week / all time.

The screenshot shows the VersaClimber Home Screen with the following callouts:

- All time total feet climbed:** 370,530 ft
- History of past workouts:** A bar chart showing 'Past 7 Days' of activity.
- Weekly calories:** 29.70
- Weekly watts:** 521
- Weekly workouts:** 12
- Monthly subscription required:** Access to 100's of LIVE and On-Demand training classes. Compete against other climbers via leaderboards.
- Monument Challenges:** A section for challenges with a 'START' button.

6. Start Workout

To START WORKOUT



TAP "OK" To allow access to USB Serial

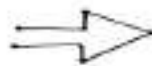



Stroke Length

Stroke length is now shown on the left with the height in inches at the top, and categorized as "short", "medium" or long". This goes along with how studios are coaching members on VersaClimbers around the country & world.

Average Feet Per Minute

Percent of Max is a learning-metric that is about you. The app monitors the max number of feet you can climb in a minute and remembers that as your max. Your current speed is shown as a percentage of your max. Why? this allows for zone-based training like what it done with heart rate.

Calories Burned

Calories are now shown and the amount you burn is a function of your speed and weight. By default it used the assumed weight of 160lbs. This can be changed by long-pressing the calories icon and entering your actual weight.

SAVE and EXIT

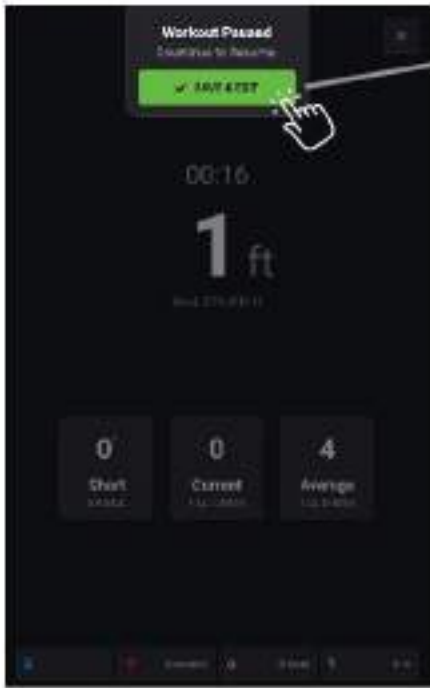

SAVE and EXIT window will appear after 7 seconds of inactivity.

TAP Save & Exit.
This will save your current workout - will automaticall update the app.

To view PAST WORKOUTS

To see PREVIOUS WORKOUTS
TAP the WORKOUTS link button
on the upper left:



TAP past workout to view workout analytics.



Stroke length
Short / Middle / Long

Feet Per Minute
Graph

Heart Rate

To set up heart rate:

1. Put on your chest strap heart rate monitor
2. Begin a workout on the VersaClimber
3. Tap the heart icon at the bottom of the workout recording screen and select your heart rate monitor

That's it! It will automatically look for your heart rate monitor on every workout thereafter (on any model TS or VersaBlue SM).

*The app is compatible with any BLE heart rate monitor that is "open" (meaning, "no proprietary"). Garmin, Apple Watch, certain Polar straps, and some others WILL NOT WORK. If you search Amazon for "BLE Heart Rate Monitor" you will get a good idea of compatible straps. My personal fav: the Scosche Rhythm +.

Troubleshooting Guide

If you are having any problems try the following steps:

Symptom:

The touchscreen is on, but no data shows when you climb, try the following:

- 1) Press the lower left corner of tablet multiple times to reload app. You will see a number code that looks something like this: 0574a - 5.00.10 Force Reload 115

Force Reload of app
(Tap once to bring up,
followed by 4 multiple
taps.



- 2) Power off the touchscreen, and then unplug power cord. Wait 15 seconds, then plug back in. Turn on tablet by pressing and holding the side power button.

Symptom:

If you are seeing the Offline Screen instead of the Online Screen

- 1) Be sure you are connected to WIFI. If it says "Saved" the password is wrong. If it says "Connected" then the password is right and it is connected.
- 2) Be sure that your wifi router is working and internet is available.

Have questions?



Need to talk to us?
Call 1-800-237-2271



email us: support@versaclimber.com



ROLLER AND SLIDE BEARINGS

There are rollers and slide bearings made from high pressure application moly-disulfide filled nylon on each oscillating bar. The roller bearings are held on with 3/8" shafts and press-on grip rings. The slide bearings are held in place with two 3/8" pins. The slide bearings have lubrication points. This bearing material is expected to be maintenance free for years. The bearings are lightly lubricated at the factory and the wear life and smooth operation of the machine can be assured by lubricating every two months or sooner if required. Lubricate with any good quality synthetic lubricant - Planet Safe Lubricants AIM lube.

First wipe any excess oil, lint, dirt, etc. from all internal accessible surfaces of the rectangular tubing. Move the bars up and down to allow access to clean the two foot pedal slots and the two hand grip slots. Use paint thinner to remove the oil and lint residue. When clean, wipe or spray a synthetic lubricant on all four internal surfaces of the rectangular tubing. We recommend Planet Safe Lubricants AIM lube. www.planetsafelubricants.com



AIM grease and lubricants combines our proprietary bio-synthetic compound with a high performance Lithium/Moly base. Our nano-particle component bonds ionically to metal for extra lubricity and reduced rolling friction. It is designed to provide superior protection under extreme conditions. Maximum wear, rust, corrosion, and salt water protection. PlanetSafe AIM is non-toxic, non-hazardous, with virtually no smell.

PREVENTATIVE MAINTENANCE SCHEDULE

For detailed overview please visit www.versaclimber.com/maintenance-service/

Daily:

1. Wipe down the main post, base and side rails with a rag and non-solvent, non-ammonia cleaning solution.

Weekly:

1. Hand check quick-release handle bushings, which the handles lock into, on both sides to make sure they are tight.
2. Check oil level in top reservoir, it should be at least 3/4 full--this should never dip below.
 - A) If oil level is low, fill using 80/90 gear oil. Oil level should remain at 3/4 full.
 - B) If you notice the oil has turned dark or black, this is normal. Oil never has to be changed.

Quarterly:

Wipe off the top & bottom chains and put a very light coat of Planet Safe Lubricant grease on chain. Using a toothbrush, or firm paint brush, brush on grease on exposed chain only. Grease can be purchased at www.planetsafelubricants.com.

NOTE: The chain is the ONLY place you will use grease on the VersaClimber.
For more details please visit www.versaclimber.com/maintenance-service/

1. Heart Rate Inc. (H.R.I.) warrants to the original purchaser that the TS is free from defects in material and workmanship under normal use and proper maintenance with a three-year limited warranty subject to the terms and conditions hereafter set forth. Except for the above warranty, it is expressly agreed that NO WARRANTY OF MERCHANTABILITY OR FITNESS FOR A PARTICULAR PURPOSE or of a particular use nor any warranty of any kind whatsoever express, implied or statutory is made by H.R.I.
2. This warranty does not cover any damage caused misuse, tampering, negligence, accidents, abnormal conditions, lack of adequate maintenance or unauthorized service or alterations to the product.
3. Liability of H.R.I. is limited to either repair or replacement of the defective part or the replacement of the machine at the option of H.R.I. on an exchange basis, with the customer bearing all costs of shipping and handling to and from the factory.
4. Length of Warranty, Parts.

ITEM PARTS REPLACEMENT:

3 YEAR

FRAME, HANDRAILS, BASE SUPPORT	3 YEARS
HYDRAULIC MOTOR	3 YEARS

2 YEAR

FOOT PEDALS	2 YEARS
HANDLES	2 YEARS
CHAINS AND SPROCKETS	2 YEARS
ROLLERS AND SLIDES	2 YEARS

1 YEAR

ELECTRONICS	1 YEAR
HAND GRIP	1 YEAR
FOOT PEDAL STRAPS	1 YEAR
HANDRAIL FOAM COVERS	1 YEAR

5. Length of Warranty, Labor
During the first year, all labor is covered by the warranty. All labor repairs for warranty and non-warranty parts will be performed at the factory. The cost of shipping to and from the factory is the responsibility of the warranty.
6. This warranty does not cover paint deterioration, discoloration, chipping or rust.
7. After all of the foregoing conditions have been complied with, if H.R.I. shall thereupon attempt repairs and /or replacements which shall for any reason fail, H.R.I. shall be allowed to continue to attempt to remedy any defects for so long a period of time as, In H.R.I. sole judgment, such attempt is justified.
8. The foregoing shall be buyer's sole and exclusive remedy, whether based on tort or otherwise, and H.R.I. shall not be liable for any injuries to persons or property. In no event shall H.R.I. be liable for incidental or consequential damages for commercial losses or for any other loss or damages except as above set forth.
9. This warranty is expressly in lieu of all other warranties, express or implied, and of all other obligations or liabilities on the part of H.R.I. No person, firm or corporation is authorized to assume any other liability on behalf of H.R.I.